

ENT TREATMENT UNIT

OPTIMUS

OPTIMIZING SPACE IN THE ENT CONSULTATION ROOM

- All-in-one solution
- Elegant and smart design
- Spacious work surfaces and drawers



producing quality

Design and optimization of space go hand in hand in the OPTIMUS ENT treatment unit

Leader in high-precision OPTO-MECHANICAL systems

The OPTIMUS ENT treatment unit only occupies 0.5 m² of floor space and altogether provides more than 3 m² of usable space, including work surfaces, drawers and shelves.

Used together with OPTOMIC's ENT chairs, the result is an outstanding combination of efficiency and ergonomics in ENT examination.

The OPTIMUS treatment unit can also be fitted with endoscopy equipment, such as the cameras and cold light sources manufactured by OPTOMIC or other brands available in the market.

This way the endoscopy trolley is fully integrated in the OPTIMUS treatment unit, thus saving space.

With the addition of an OP-C12 ENT examination microscope, the result is a complete unit that adapts to the most demanding requirements of today's ENT consulting room.

With the OPTIMUS treatment unit there is no need for additional drawer cabinets, tables, cupboards, microscopes with wheeled stands, suction systems and endoscopy trolleys. Today, all of this can be combined in the OPTIMUS ENT treatment unit occupying only 0.5 m² of floor space.



ENT TREATMENT UNIT OPTIMUS



OPTI



SLIDE-OUT TRAY



WASTE BIN WITH ELECTROMAGNETIC OPENING



MIRROR HEATER



FLEXIBLE ENDOSCOPE HOLDER / HEATER



RIGID ENDOSCOPE HOLDER / HEATER



HINGED TOP



MUS



CAMERA HEAD AND FIBER OPTIC CABLE HOLDER



HEAD LAMP HOLDER

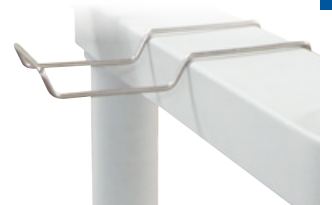

WASTE BIN OPENING BUTTON



FOLD-UP WORK TABLE



HIGH POWER SUCTION SYSTEM



USED INSTRUMENTS TRAY



ENT TREATMENT UNIT OPTIMUS

DRAWERS, SHELVES and TRAYS



TOP DRAWER, HEIGHT 4.5 CM

Accessible either by lifting the hinged laminated glass tops or sliding the drawer out.



2ND AND 3RD DRAWERS, HEIGHT 5.5 CM

For instruments and accessories.

4TH DRAWER, HEIGHT 8 CM

For larger instruments, glove boxes, gauze and medicines.

2 DRAWERS, HEIGHT 12.5 CM

The unit has 2 deep drawers for large and heavy items. They are fitted with a lock and key for security.



Drawer cabinet with 4 spacious drawers and a slide-out work surface. All drawers slide out fully on highly-resistant slides with damper system and automatic final closure.

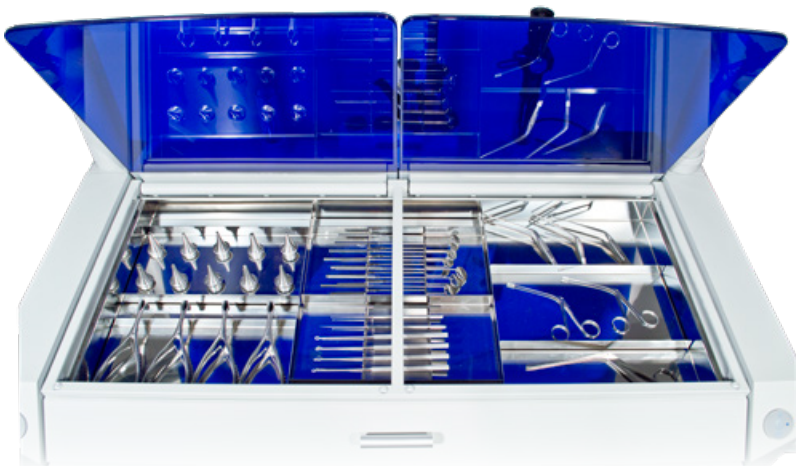

ENT TREATMENT UNIT OPTIMUS

FOLD-UP WORK TABLE

On both sides of the unit to increase the number of work surfaces, providing space for a laptop, to write, etc.

Made of sheet steel with highly-resistant self-extending brackets.

The outer surface is made of laminated glass.



SHELVES

Made of laminated glass to set up equipment for video endoscopy, stroboscopy, electrosurgery, CPU, etc.

REAR DOORS

Access to cables, interconnection of devices and power supply.



Slide-out tray with stainless steel receptacle for used instruments. The rest of the work surface can be used to set down instruments or write.



ENT TREATMENT UNIT OPTIMUS

MAXIMUM UTILITY IN THE MINIMUM SPACE

RIGID AND FLEXIBLE ENDOSCOPES ORGANIZED, CLEAN, SAFE AND HEATED

HOLDER FOR 4 RIGID ENDOSCOPES

Disinfectable internal sheaths.



HOLDER FOR DISINFECTION OF FLEXIBLE ENDOSCOPE

Open perspex tube, aired and disinfectable and closed perspex tube.

HEATER FOR RIGID ENDOSCOPES

Holder with heating system for endoscopes with On-Off switch. Automatic temperature control at 37°C.

HEATER FOR FLEXIBLE ENDOSCOPE

Holder with heating system for a flexible endoscope with On-Off switch. Automatic temperature control at 37°C.



INTERNAL LED LIGHTING

LED illumination with light condenser on both sides of the top drawer for instruments.



MIRROR HEATER

Mirror heating tray with capacity for 11 circular mirrors of different sizes.

Automatic temperature control at 37°.

Supporting tray and organizing tray in stainless steel, removable for disinfection.

On-Off switch.

Automatic disconnection when opening the top drawer.

CAMERA HEAD AND FIBER OPTIC CABLE HOLDER



HEAD LAMP HOLDER



ENT TREATMENT UNIT OPTIMUS

HIGH POWER SUCTION SYSTEM

The built-in and silent suction system is vibration-free, making it possible to use the microscope and the suction system simultaneously.



SUCTION PUMP

German made with high flow rate: 70 litres per minute.
Bacterial filter to prevent the passage of fluids.



CONTAINER

Easy access to clean the 1,500 cc autoclavable container with filler valve.



PRESSURE GAUGE AND REGULATOR

This enables the suction flow rate to be regulated during interventions.



SUCTION TUBE HOLDER

Automatic shut-off when the suction hose is replaced in its holder.

The magnetic holder can be positioned on the left or right.

THICK SILICONE TUBE

Easy maintenance and cleaning of the tubes and filter.
Spare suction tube and filter.



WASTE BIN

Activated by an electromagnet.

At the touch of the button (left or right), the waste bin automatically slides out.



ELECTRICAL SAFETY AND CONNECTIONS

The entire electrical installation is protected by insulated wiring.



8-SOCKET INTERNAL SAFETY CONNECTION
(4 ON EACH SIDE)

ELECTRIC SWITCH WITH
SURGE PROTECTION



COLOURED LAMINATED GLASS

The coloured laminated glass is made by sandwiching several coloured sheets of polyvinyl butyral between two 3 mm glass sheets to bond the glass with a single adhesion.

As well as providing a wide range of colours, this also makes the glass highly resistant and, in the event of breakage, the fragments do not detach.

The OPTIMUS treatment unit's work tops, tables and shelves are made of this material and are available in a variety of colours, enabling it to tastefully blend in with the rest of the consulting room.

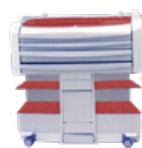





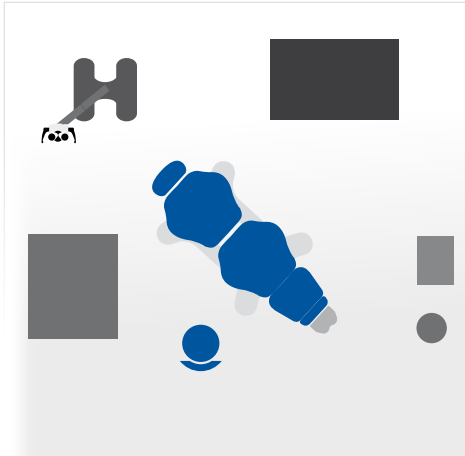

INTELLIGENT SPACE SAVING OPTIMUS

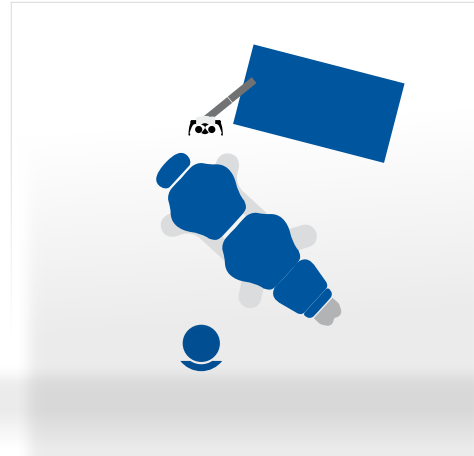
A typical consulting room
Layout for illustration purposes



An OPTIMUS consulting room
Layout for illustration purposes



Endoscopy tower		$0.7\text{m} \times 0.6\text{m} = 0.42\text{m}^2$
Microscope		$0.7\text{m} \times 0.7\text{m} = 0.49\text{m}^2$
Drawer cabinet for instruments		$0.8\text{m} \times 0.5\text{m} = 0.40\text{m}^2$
Suction system		$0.04 \times 0.03\text{m} = 0.12\text{m}^2$
Waste bin		$0.03 \times 0.03\text{m} = 0.09\text{m}^2$

OPTIMUS		$0.95\text{m} \times 0.5\text{m} = 0.47\text{m}^2$
---------	---	--



1.5 m²

0.5 m²



TECHNICAL SPECIFICATIONS OPTIMUS

OPTIMUS

SUCTION SYSTEM	70 liters/minute, automatic start up
PRESSURE GAUGE AND REGULATOR	Gradual regulation
AUTOMATIC WASTE BIN	9 liters
6 DRAWERS	1 of 79 cm x 34 cm, height 4.5 cm 2 of 79 cm x 40 cm, height 5.5 cm 1 of 79 cm x 40 cm, height 8 cm 2 of 28 cm x 39 cm, height 12.5 cm
9 WORK SURFACES	1 slide-out tray of 79 cm x 40 cm 2 fold-up work tables of 29,5 cm x 33 cm 2 hinged glass tops of 37 cm x 40 cm 4 glass shelves of 34 cm x 40 cm
ENDOSCOPE HOLDERS	4 rigid and 2 flexible
GLASS COLOURS	6 colours available
MOBILE	4 wheels
WEIGHT WITHOUT ACCESSORIES	195 kg
MAXIMUM CONSUMPTION OF PERIPHERALS	800 W
MAXIMUM TOTAL CONSUMPTION	1600 W
OPTIONAL ACCESSORIES	ENT microscope support Lateral or straight monitor support Head lamp holder Endoscopy camera head and fiber optic cable holder Mirror heater Endoscope heater

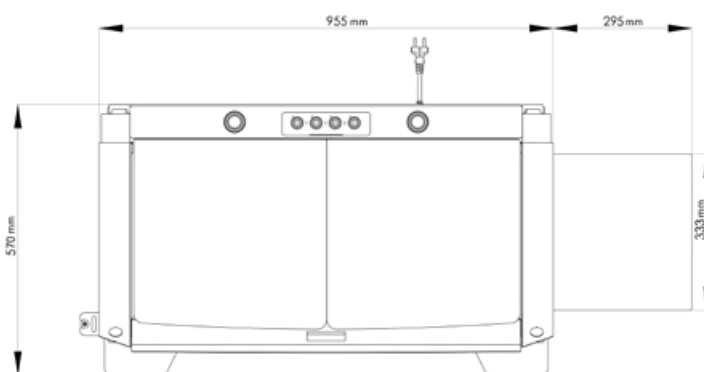
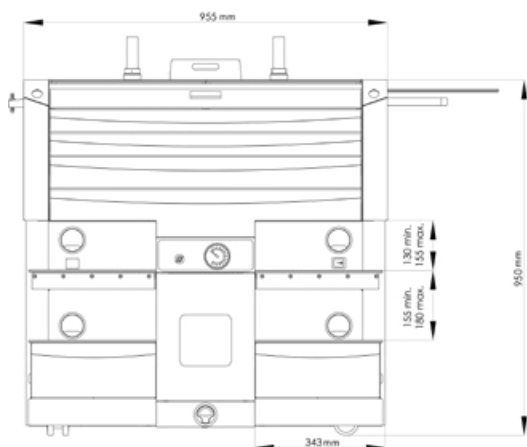

OPTOMIC ESPAÑA S.A.

Madroño, 4. E-28770 Colmenar Viejo, Madrid, Spain
Tel: +34 91 804 44 44 • Fax: +34 91 803 84 14
export@optomic.com • www.optomic.com



Specifications are subject to change without notice

